

A2

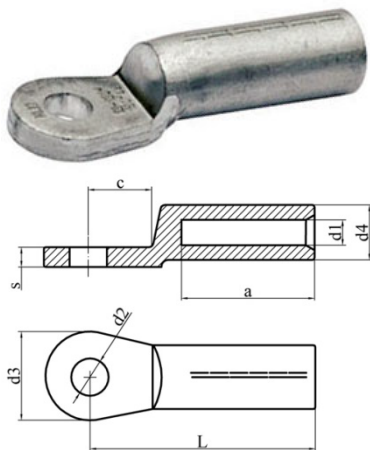

Aluminium Compression Lugs and Joints





DIN Compression Cable Lugs

Features

- Manufactured according to DIN 46329
- With marking for correct crimping

Material:

- Al 99.5%

Surface:

- Bright or Tin-plated

Part No.	Item	Cross Section mm ²	Size of Bolt Φ	Dimension(mm)							
				L	a	c	d4	d1	d3	s	d2
A030101	DAL 16-8	16	M 8	50.0	30.0	15.5	12.0	5.8	20.0	4.0	8.4
A030102	DAL 16-10		M 10	50.0	30.0	15.5	12.0	5.8	20.0	4.0	10.5
A030103	DAL 25-8	25	M 8	50.0	30.0	15.5	12.0	6.8	25.0	4.0	8.4
A030104	DAL 25-10		M 10	50.0	30.0	15.5	12.0	6.8	25.0	4.0	10.5
A030105	DAL 25-12		M 12	50.0	30.0	15.5	12.0	6.8	25.0	4.0	13.0
A030106	DAL 35-8	35	M 8	62.0	42.0	15.5	14.0	8.0	25.0	4.0	8.4
A030107	DAL 35-10		M 10	62.0	42.0	15.5	14.0	8.0	25.0	4.0	10.5
A030108	DAL 35-12		M 12	62.0	42.0	15.5	14.0	8.0	25.0	4.0	13.0
A030109	DAL 50-8	50	M 8	62.0	42.0	15.5	16.0	9.8	25.0	5.5	8.4
A030110	DAL 50-10		M 10	62.0	42.0	15.5	16.0	9.8	25.0	5.5	10.5
A030111	DAL 50-12		M 12	62.0	42.0	15.5	16.0	9.8	25.0	5.5	13.0
A030112	DAL 70-8	70	M 8	72.0	52.0	15.5	18.5	11.2	25.0	5.5	8.4
A030113	DAL 70-10		M 10	72.0	52.0	15.5	18.5	11.2	25.0	5.5	10.5
A030114	DAL 70-12		M 12	72.0	52.0	15.5	18.5	11.2	25.0	5.5	13.0
A030115	DAL 95-8	95	M 8	77.0	56.0	15.5	22.0	13.2	25.0	6.0	8.4
A030116	DAL 95-10		M 10	77.0	56.0	15.5	22.0	13.2	25.0	6.0	10.5
A030117	DAL 95-12		M 12	77.0	56.0	15.5	22.0	13.2	25.0	6.0	13.0
A030118	DAL 120-10	120	M 10	82.0	56.0	20.0	23.0	14.7	30.0	7.5	10.5
A030119	DAL 120-12		M 12	82.0	56.0	20.0	23.0	14.7	30.0	7.5	13.0
A030120	DAL 120-16		M 16	82.0	56.0	20.0	23.0	14.7	30.0	7.5	17.0
A030121	DAL 150-10	150	M 10	90.0	60.0	20.0	25.0	16.3	30.0	8.0	10.5
A030122	DAL 150-12		M 12	90.0	60.0	20.0	25.0	16.3	30.0	8.0	13.0
A030123	DAL 150-16		M 16	90.0	60.0	20.0	25.0	16.3	30.0	8.0	17.0
A030124	DAL 185-10	185	M 10	91.0	60.0	20.0	28.5	18.3	30.0	8.0	10.5
A030125	DAL 185-12		M 12	91.0	60.0	20.0	28.5	18.3	30.0	8.0	13.0
A030126	DAL 185-16		M 16	91.0	60.0	20.0	28.5	18.3	30.0	8.0	17.0
A030127	DAL 240-12	240	M 12	103.0	70.0	24.0	32.0	21.0	38.0	11.0	13.0
A030128	DAL 240-16		M 16	103.0	70.0	24.0	32.0	21.0	38.0	11.0	17.0
A030129	DAL 240-20		M 20	103.0	70.0	24.0	32.0	21.0	38.0	11.0	21.0
A030130	DAL 300-12	300	M 12	103.0	70.0	24.0	34.0	23.3	38.0	13.0	13.0
A030131	DAL 300-16		M 16	103.0	70.0	24.0	34.0	23.3	38.0	13.0	17.0
A030132	DAL 300-20		M 20	103.0	70.0	24.0	34.0	23.3	38.0	13.0	21.0
A030133	DAL 400-12	400	M 12	116.0	73.0	24.0	38.5	26.0	38.5	14.0	13.0
A030134	DAL 400-16		M 16	116.0	73.0	24.0	38.5	26.0	38.5	14.0	17.0
A030135	DAL 400-20		M 20	116.0	73.0	24.0	38.5	26.0	38.5	14.0	21.0
A030136	DAL 500-12	500	M 12	122.0	79.0	24.0	44.0	29.0	44.0	15.0	13.0
A030137	DAL 500-16		M 16	122.0	79.0	24.0	44.0	29.0	44.0	15.0	17.0
A030138	DAL 500-20		M 20	122.0	79.0	24.0	44.0	29.0	44.0	15.0	21.0

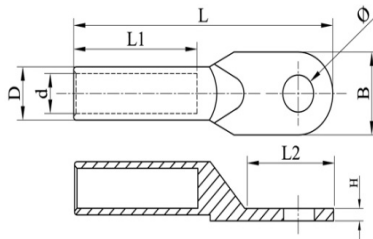

Compression Cable Lugs

Features

- Made of aluminium rod with oil stop

Material:

- Al 99.5%

Surface:

- Bright or Tin-plated

Part No.	Item	Cross Section mm ²	Size of Bolt Φ	Dimension(mm)								
				D	d	L	L1	L2	B	Φ	E	H
A030201	DL 16-6	16	M 6	10.0	5.8	70.0	32.0	22.0	16.0	6.5	1.5	3.0
A030202	DL 16-8		M 8	10.0	5.8	70.0	32.0	22.0	16.0	8.5	1.5	3.0
A030203	DL 25-8	25	M 8	12.0	7.2	75.0	34.0	25.0	17.5	8.5	1.5	3.0
A030204	DL 25-10		M 10	12.0	7.2	75.0	34.0	25.0	17.5	10.5	1.5	3.0
A030205	DL 35-10	35	M 10	14.0	8.5	85.0	40.0	27.0	20.0	10.5	1.5	3.6
A030206	DL 35-12		M 12	14.0	8.5	85.0	40.0	27.0	20.0	13.0	1.5	3.6
A030207	DL 50-10	50	M 10	16.0	9.7	90.0	42.0	30.0	23.0	10.5	1.5	4.2
A030208	DL 50-12		M 12	16.0	9.7	90.0	42.0	30.0	23.0	13.0	1.5	4.2
A030209	DL 70-12	70	M 12	18.0	11.5	100.0	47.0	33.0	26.0	12.5	1.5	4.6
A030210	DL 95-12	95	M 12	20.0	13.5	110.0	50.0	36.0	28.0	12.5	2.0	4.8
A030211	DL 120-14	120	M 14	22.0	15.0	120.0	53.0	40.0	31.0	14.5	2.0	5.2
A030212	DL 150-14	150	M 14	24.0	16.5	125.0	55.0	42.0	35.0	14.5	2.0	5.8
A030213	DL 185-16	185	M 16	27.0	18.5	133.0	58.0	45.0	37.5	17.0	2.0	6.5
A030214	DL 240-16	240	M 16	30.0	21.0	140.0	60.0	48.0	40.0	17.0	2.0	7.0
A030215	DL 300-18	300	M 18	34.0	23.5	160.0	70.0	54.0	44.5	18.5	2.0	8.0
A030216	DL 300-20		M 20	34.0	23.5	160.0	70.0	54.0	44.5	21.0	2.0	8.0
A030217	DL 400-20	400	M 20	40.0	27.0	170.0	70.0	60.0	50.0	21.0	2.0	8.0

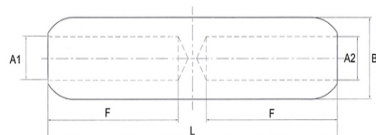

EDF Compression Joints

Features

- Manufactured according to EDF HN68S90
- For identical cross-sections
- Barrier design with oil stop

Material:

- Al 99.5%

Surface:

- Bright or Tin-plated

Part No.	Item	Cross Section mm ²	Dimension(mm)			
			L	F	B	A1/A2
A040101	RJ-0A-16	16	91.0	42.0	16	5.5
A040102	RJ-0A-25	25	91.0	42.0	16	6.5
A040103	RJ-0A-35	35	91.0	42.0	16	8.0
A040104	RJ-1A-50	50	107.0	48.0	20	9.0
A040105	RJ-1A-70	70	107.0	48.0	20	11.0
A040106	RJ-1A-95	95	107.0	48.0	20	12.5
A040107	RJ-2A-120	120	133.0	60.0	25	13.7
A040108	RJ-2A-150	150	133.0	60.0	25	15.5
A040109	RJ-4A-185	185	143.0	65.0	32	17.0
A040110	RJ-4A-240	240	143.0	65.0	32	19.5
A040111	RJ-5A-300	300	216.0	100.0	40	23.3
A040112	RJ-5A-400	400	216.0	100.0	40	26.0
A040113	RJ-6A-500	500	216.0	105.0	47	29.0
A040114	RJ-6A-630	630	216.0	105.0	47	32.5

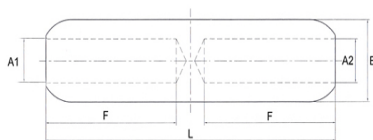

EDF Compression Joints

Features

- Manufactured according to EDF HN68S90
- For unidentical cross-sections
- Barrier design with oil stop

Material:

- Al 99.5%

Surface:

- Bright or Tin-plated

Part No.	Item	Cross Section mm ²		Dimension(mm)				
		Cable 1	Cable 2	A1	A2	B	L	F
A040201	RJ-1A 50-25	50	25	9.0	6.5	20.0	106.5	51.3
A040202	RJ-1A 50-35	50	35	9.0	8.0	20.0	106.5	51.3
A040203	RJ-1A 70-50	70	50	11.0	9.0	20.0	106.5	51.3
A040204	RJ-1A 95-25	95	25	12.5	6.5	20.0	106.5	51.3
A040205	RJ-1A 95-35	95	35	12.5	8.0	20.0	106.5	51.3
A040206	RJ-1A 95-50	95	50	12.5	9.0	20.0	106.5	51.3
A040207	RJ-1A 95-70	95	70	12.5	11.0	20.0	106.5	51.3
A040208	RJ-2A 150-35	150	35	15.5	8.0	25.0	133.0	64.0
A040209	RJ-2A 150-50	150	50	15.5	9.0	25.0	133.0	64.0
A040210	RJ-2A 150-70	150	70	15.5	11.0	25.0	133.0	64.0
A040211	RJ-2A 150-95	150	95	15.5	12.5	25.0	133.0	64.0
A040212	RJ-2A 150-120	150	120	15.5	13.7	25.0	133.0	64.0
A040213	RJ-4A 240-70	240	70	19.5	11.0	32.0	143.5	69.0
A040214	RJ-4A 240-95	240	95	19.5	12.5	32.0	143.5	69.0
A040215	RJ-4A 240-120	240	120	19.5	13.7	32.0	143.5	69.0
A040216	RJ-4A 240-150	240	150	19.5	15.5	32.0	143.5	69.0
A040217	RJ-4A 240-185	240	185	19.5	17.0	32.0	143.5	69.0

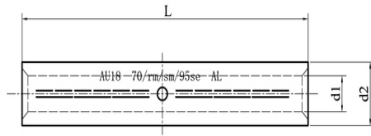

DIN Compression Joints

Features

- Manufactured according to DIN 46267
- With marking for correct crimping

Material:

- Al 99.5%

Surface:

- Bright or Tin-plated

Part No.	Item	Cross Section mm ²	Dimensions(mm)		
			L	d2	d1
A040301	DAJ 16	16	55.0	12.0	5.8
A040302	DAJ 25`	25	70.0	12.0	6.8
A040303	DAJ 35	35	85.0	14.0	8.0
A040304	DAJ 50	50	85.0	16.0	9.8
A040305	DAJ 70	70	105.0	18.5	11.2
A040306	DAJ 95	95	105.0	22.0	13.2
A040307	DAJ 120	120	105.0	23.0	14.7
A040308	DAJ 150	150	125.0	25.0	16.3
A040309	DAJ 185	185	125.0	28.5	18.3
A040310	DAJ 240	240	145.0	32.0	21.0
A040311	DAJ 300	300	145.0	34.0	23.3
A040312	DAJ 400	400	210.0	38.5	26.0
A040313	DAJ 500	500	210.0	44.0	29.0
A040314	DAJ 630	630	210.0	47.0	32.5

Aluminium Compression Lugs and Joints

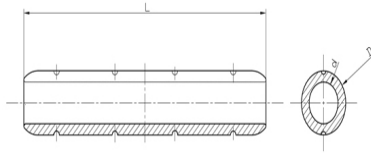

Compression Joints

Features

- With marking for correct crimping

Material:

- Al 99.5%

Surface:

- Bright or Tin-plated

Part No.	Item	Cross Section mm ²	Dimension(mm)		
			L	D	d
A040401	SAJ 16	16	90.0	11.0	6.0
A040402	SAJ 25	25	90.5	16.0	6.5
A040403	SAJ 35	35	90.5	16.0	8.0
A040404	SAJ 50	50	106.5	20.0	9.5
A040405	SAJ 70	70	106.5	20.0	11.0
A040406	SAJ 95	95	106.5	20.0	12.5
A040407	SAJ 120	120	133.0	25.0	13.7
A040408	SAJ 150	150	133.0	25.0	15.5
A040409	SAJ 185	185	143.5	32.0	17.0
A040410	SAJ 240	240	143.5	32.0	19.5
A040411	SAJ 300	300	218.0	40.0	23.3
A040412	SAJ 400	400	218.0	40.0	26.0
A040413	SAJ 500	500	218.5	47.0	29.1
A040414	SAJ 630	630	218.5	47.0	32.5

Compression Joints

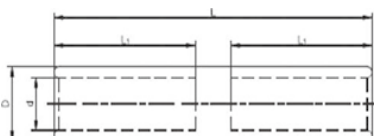

Features

- With barrier for Oil-stop

Material:

- Al 99.5%

Surface:

- Bright

Part No.	Item	Cross Section mm ²	Dimensions(mm)			
			D	d	L1	L
A040501	GL-10	10	9	5.3	28	65
A040502	GL-16	16	10	6.3	32	75
A040503	GL-25	25	12	7.3	35	80
A040504	GL-35	35	14	8.5	40	90
A040505	GL-50	50	16	9.8	43	95
A040506	GL-70	70	18	11.5	47	105
A040507	GL-95	95	21	13.5	50	110
A040508	GL-120	120	23	15.0	52	115
A040509	GL-150	150	25	16.5	55	120
A040510	GL-185	185	27	18.5	58	125
A040511	GL-240	240	30	21.0	60	130
A040512	GL-300	300	34	24.0	65	145
A040513	GL-400	400	38	27.0	75	158
A040514	GL-500	500	42	29.0	75	165